

Data Sheet



Article number: 0108064

Description: Retaining ring JK 47 DIN 984

Measures

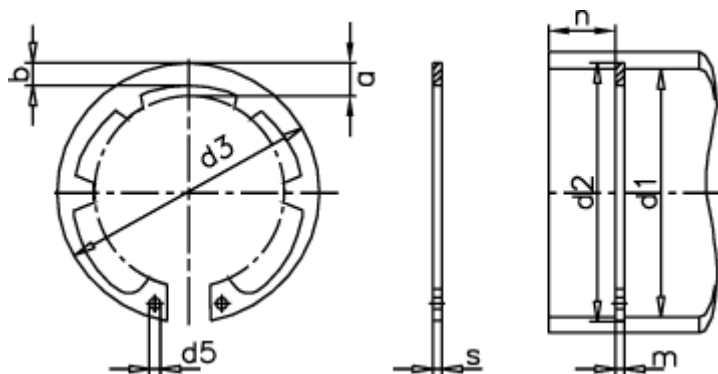

a max	= 7.2	FN kN	= 31.4	s	= 1.75
AN mm ²	= 189.0	FRg kN	= 8.3	t	= 1.25
b	= 4.5	FR kN	= 43.5	tol	= +0,25
d1	= 47	g	= 2.0	tol	= -0.06
d2	= 49.5	K kN-mm	= 78.9	tol	= +1,10-0,46
d3	= 50.5	m min	= 1.85	Tong	= ZGJ-3
d5 min	= 2.5	Nominal drive	= 3.8	Weight kg/1000	= 6.90
Description	= JK 47	Number of serrations	= 6		